

Nutrient Doser

Quick Start Guide

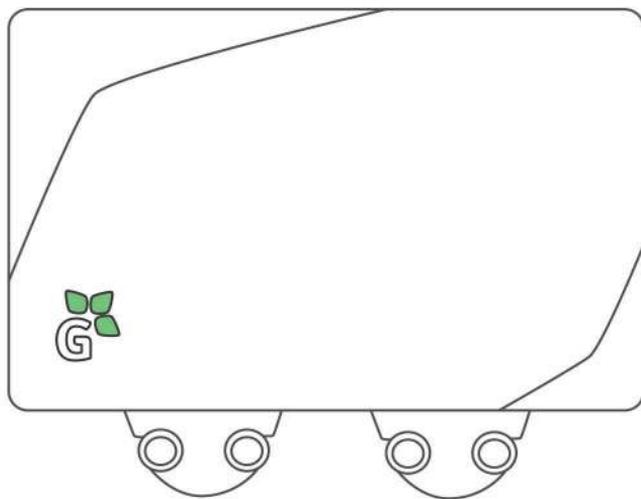

What's In The Box

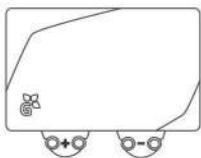

Nutrient Doser



Add-on Cable

Add as many Nutrient Dosers as you need to create your unique feeding solution.

Maintain balanced pH levels with the pH Balancer add-on.

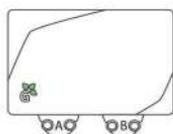

Nutrient
Doser

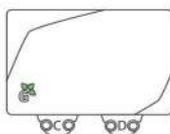

Nutrient
Doser

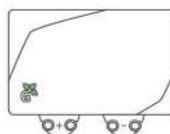

pH
Balancer

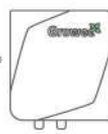

Hydro
Master

Set Up Your Nutrient Doser

Important notice:

- The Nutrient Doser is an add-on to the Growee Hydro Master. It cannot be operated independently.
- Use a 4/7 mm irrigation pipe for the pumps. The tube length must not exceed 23 inches.

Step 1: Disconnect the Hydro Master from the power supply



Step 2: Install the Nutrient Doser on the wall

A. Place the Nutrient Doser on the **left side** of the Hydro Master or the pH Balancer, if already installed, at a maximum distance of 3.5 inches.

B. Make sure the ends of the tubes can reach the tank and are well above the water level at all times. Avoid all contact between the tubes and the water in the tank.

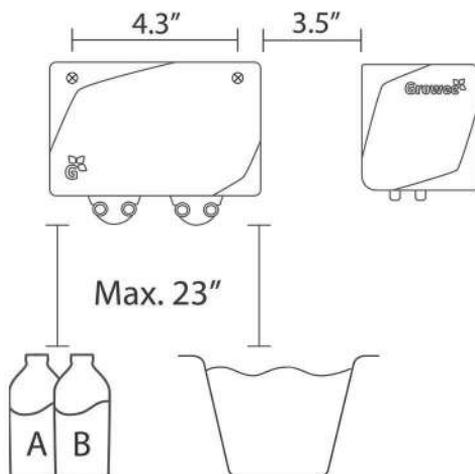

Step 3: Connect the Nutrient Doser to the Hydro Master

A. Use the connecting cable to connect the Nutrient Doser to the Growee Hydro Master or pH Balancer if already installed.

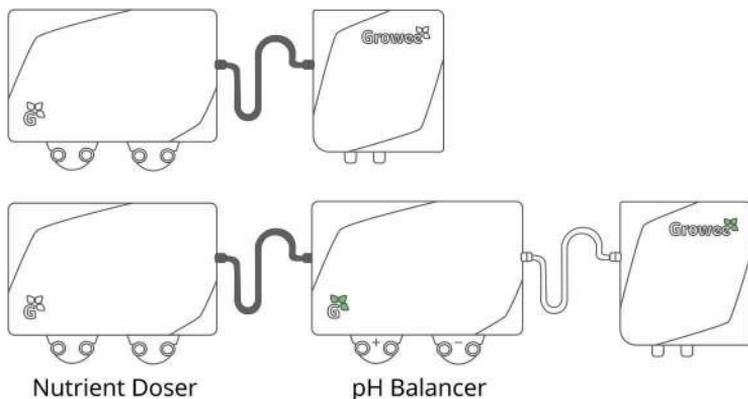

B. Connect the Hydro Master to the power and wait until the Hydro Master indicator light is solid green. It should take up to 1 minutes.

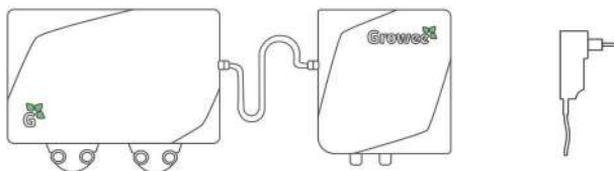

C. If the indicator light continues to blink after 1 min:

- Disconnect the Hydro Master from the power supply.
- Make sure the connecting cable is securely attached to both devices.
- Reconnect the Hydro Master to the power supply.

Step 4: Connect the tubes to the pumps

A. With two 23-inch long tubes, connect the pump fittings marked with **↑** to your preferred nutrient solution.

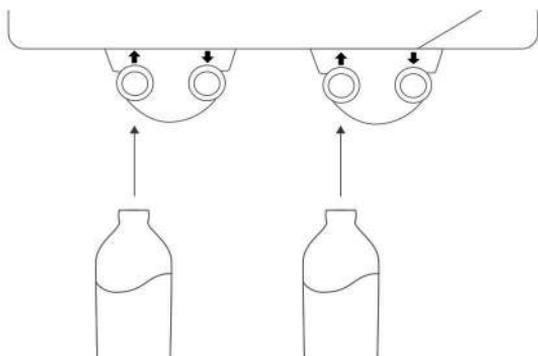

B. With another two 23-inch long tubes, connect the pump fittings marked with **↓** to the water tank. Make sure the ends of the tubes are above the tank water at all times.

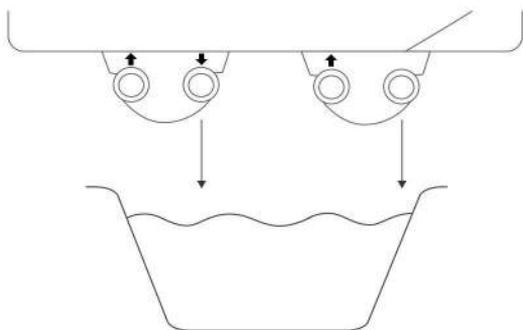

Step 5: Feed your plants with the Growee app

A. Go to www.MyGrowee.com or to your smartphone app and log in with your username and password.

B. On the main Dashboard, press on the "Nutrients" button.



C. There are two ways to manage plants feeding:

- Auto Feed - Set your desired EC range level and enter the ratio between the A and B feeding solutions according to your feeding chart, or use the feeding table recommendations provided by the nutrients manufacturer.
- Manual Feed - Enter the amount of milliliters you would like to inject from each feeding solution.

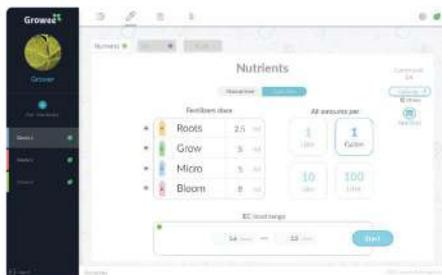

Important notice: When using the Manual-Feed function on the app, the first icon bottle on the left will control the first pump on the left. When using the Auto-Feed function on the app, the first icon bottle on the list marked as A will control the pump on the left.



For support and instructional videos, visit our website:
www.GetGrowee.com

If you still need help, don't hesitate to contact us at
Support@GetGrowee.com